

PARI2001B

Paris 25W 2500LM Dual CCT IK10 IP65 Anthracite LED Bulkhead

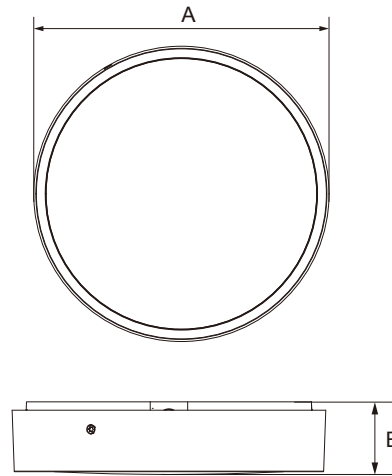

General Details

Finish	Anthracite Polycarbonate Body & Clear Polycarbonate Diffuser
Product Weight	1.7kg
Overall Dimensions	A 352mm X B 67.5mm
Bar Coding	Saturn LED coding in accordance with EAN-12 & ITF-14
IP Rating	IP65
Energy Rating	A* - (Very Low Energy)

Light Source

Wattage & Lumens	25W - 2500LM - 100 lm/W
Colour Temperature	3000K/4000K
CRI Ra	Ra > 80
Lifespan	50,000 Hours
Lamp Working Temperature	<50°C
Beam Angle	115° & 95° & 95°



Electrical

Voltage	220-240V. 50 / 60Hz. AC.
---------	--------------------------

Running Current (I)	110mA
---------------------	-------

Total Running Wattage (W)	25W
---------------------------	-----

Electrical Classification	Class II
---------------------------	----------

Power Factor Correction (PFC)	0.9
-------------------------------	-----

Cabling Electrical Connections	Screw fix in terminal block
--------------------------------	-----------------------------

LED Driver	Tridonic
------------	----------

Installation

Method of Fix	Surface mounted on a suitable substrate.
---------------	--

Recommended Working Temperature	Minimum Temp -10°C to Maximum Temp + 40°C
---------------------------------	---

Instruction Sheet	Supplied with product
-------------------	-----------------------

Origin & Markets

Country of Manufacture	Designed & tested in Europe - Manufactured in China
------------------------	---

Intended Market	Europe, Middle East & Australia 220 - 240Volt
-----------------	---

Materials

Main Housing Material	Polycarbonate
-----------------------	---------------

Fixings Main Housing	Zinc plated screws (Internal)
----------------------	-------------------------------

Front Shield	Polycarbonate Opal Diffuser
--------------	-----------------------------

Approvals

Warranty	5 Year Warranty - For more information go to www.saturnled.eu/warranty
----------	---

Marks & Symbols	CE -- SELV -- RoHS -- EMC -- WEEE
-----------------	-----------------------------------

Quality Assurance System	SaturnLED quality assurance to ISO9001:2008
--------------------------	---

Manufactured in Accordance to	British Standard - BS EN 60598 - 2 - 1
-------------------------------	--

