

BONO1002

Bono 14W 4000K IP44 LED Circular Downlight

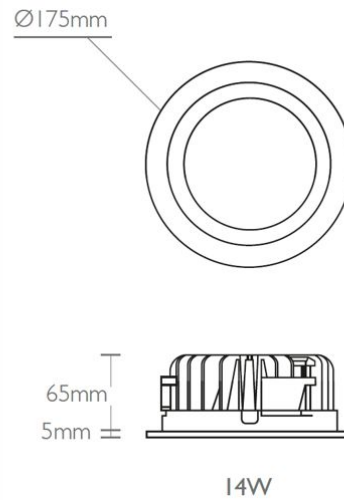

General Details

Finish	Matt White - Aluminium Base / Pmma Cover
Product Weight	0.51kg
Overall Dimensions	A 175mm X B 65mm - Cutout 155mm
Bar Coding	Saturn LED coding in accordance with EAN-12 & ITF-14
IP Rating	IP44
Energy Rating	A* - (Very Low Energy)

Light Source

Wattage & Lumens	14W - 1190LM - 85 lm/W
Colour Temperature	4000K
CRI Ra	Ra > 80
Lifespan	30,000 Hours
Lamp Working Temperature	<50°C
Beam Angle	90°



Electrical

Voltage	220-240V. 50 / 60Hz. AC.
---------	--------------------------

Running Current (I)	0.35A
---------------------	-------

Total Running Wattage (W)	14W
---------------------------	-----

Electrical Classification	Class III
---------------------------	-----------

Power Factor Correction (PFC)	0.9
-------------------------------	-----

Cabling Electrical Connections	Screw fix in terminal block
--------------------------------	-----------------------------

LED Driver	Tridonic
------------	----------

Installation

Method of Fix	Recessed into a standard ceiling or ceiling tile
---------------	--

Recommended Working Temperature	Minimum Temp -10°C to Maximum Temp + 40°C
---------------------------------	---

Instruction Sheet	Supplied with product
-------------------	-----------------------

Origin & Markets

Country of Manufacture	Designed & tested in Europe - Manufactured in China
------------------------	---

Intended Market	Europe, Middle East & Australia 220 - 240Volt
-----------------	---

Materials

Main Housing Material	Polycarbonate Trim & Diffuser, Die-cast aluminium Body
-----------------------	--

Fixings Main Housing	Spring Clips Provided
----------------------	-----------------------

Front Shield	Clear Polycarbonate Diffuser
--------------	------------------------------

Approvals

Warranty	5 Year Warranty - For more information go to www.saturnled.eu/warranty
----------	---

Marks & Symbols	CE -- SELV -- RoHS -- EMC -- WEEE
-----------------	-----------------------------------

Quality Assurance System	SaturnLED quality assurance to ISO9001:2008
--------------------------	---

Manufactured in Accordance to	British Standard - BS EN 60598 - 2 - 1
-------------------------------	--



SATURNLED[®]

Simplified

